



## 280W Module

JAP60S09 270-290/SC Series

### Introduction

This time-tested legacy module series has been proven to be one of the powerful and most reliable products offered by JA Solar and the most popular choice by PV system installers and customers around world.



5 busbar solar cell design



Low cost



Anti-PID



Highly reliable due to strict quality control

### Superior Warranty

- 12-year product warranty
- 25-year linear power output warranty

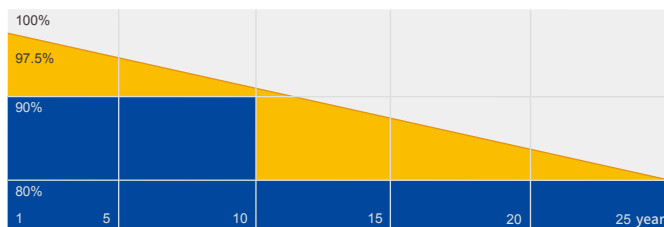

■ JA Linear Power Warranty ■ Industry Warranty

### Comprehensive Certificates

- IEC 61215, IEC 61730
- ISO 9001: 2015 Quality management systems
- ISO 14001: 2015 Environmental management systems
- OHSAS 18001: 2007 Occupational health and safety management systems
- IEC TS 62941: 2016 Terrestrial photovoltaic (PV) modules – Guidelines for increased confidence in PV module design qualification and type approval



MECHANICAL DIAGRAMS

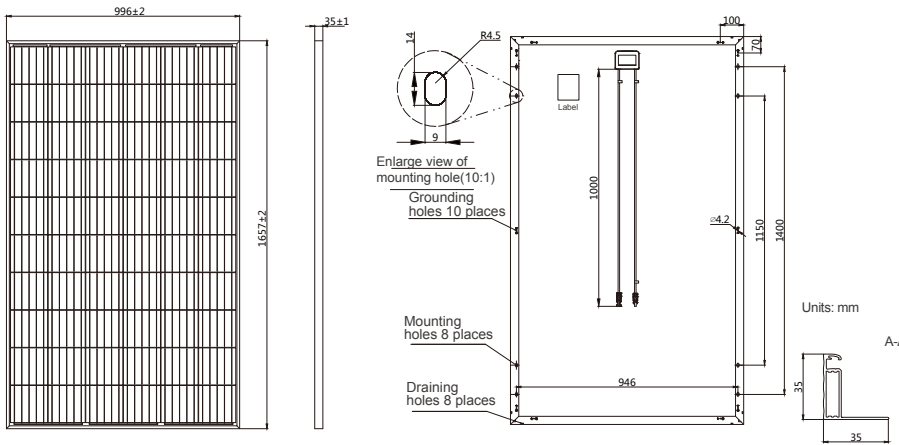

SPECIFICATIONS

Cell	Poly
Weight	18.4kg±3%
Dimensions	1657±2mm×996±2mm×35±1mm
Cable Cross Section Size	4mm <sup>2</sup>
No. of cells	60(6x10)
Junction Box	IP67, 3 diodes
Connector	QC 4.10-35
Packaging Configuration	30 Per Pallet

Remark: customized frame color and cable length available upon request

ELECTRICAL PARAMETERS AT STC

TYPE	JAP60S09 -270/SC	JAP60S09 -275/SC	JAP60S09 -280/SC	JAP60S09 -285/SC	JAP60S09 -290/SC
Rated Maximum Power(Pmax) [W]	270	275	280	285	290
Open Circuit Voltage(Voc) [V]	37.92	38.18	38.43	38.69	38.95
Maximum Power Voltage(Vmp) [V]	30.72	30.94	31.19	31.43	31.70
Short Circuit Current(Isc) [A]	9.28	9.36	9.44	9.53	9.62
Maximum Power Current(Imp) [A]	8.79	8.89	8.98	9.07	9.15
Module Efficiency [%]	16.4	16.7	17.0	17.3	17.6
Power Tolerance	0~+5W				
Temperature Coefficient of Isc(α <sub>Isc</sub> )	+0.058%/°C				
Temperature Coefficient of Voc(β <sub>Voc</sub> )	-0.330%/°C				
Temperature Coefficient of Pmax(γ <sub>Pmp</sub> )	-0.400%/°C				
STC	Irradiance 1000W/m <sup>2</sup> , cell temperature 25°C, AM1.5G				

Remark: Electrical data in this catalog do not refer to a single module and they are not part of the offer.They only serve for comparison among different module types.

ELECTRICAL PARAMETERS AT NOCT

TYPE	JAP60S09 -270/SC	JAP60S09 -275/SC	JAP60S09 -280/SC	JAP60S09 -285/SC	JAP60S09 -290/SC
Rated Max Power(Pmax) [W]	200	204	208	212	216
Open Circuit Voltage(Voc) [V]	36.25	36.56	36.85	37.05	37.26
Max Power Voltage(Vmp) [V]	29.29	29.48	29.69	29.88	30.09
Short Circuit Current(Isc) [A]	7.31	7.40	7.48	7.56	7.64
Max Power Current(Imp) [A]	6.83	6.92	7.01	7.10	7.18
NOCT	Irradiance 800W/m <sup>2</sup> , ambient temperature 20°C, wind speed 1m/s, AM1.5G				

OPERATING CONDITIONS

Maximum System Voltage	1000V/1500V DC(IEC)
Operating Temperature	-40°C~+85°C
Maximum Series Fuse	20A
Maximum Static Load,Front	5400Pa
Maximum Static Load,Back	2400Pa
NOCT	45±2°C
Application Class	Class A

CHARACTERISTICS

Current-Voltage Curve JAP60S09-280/SC

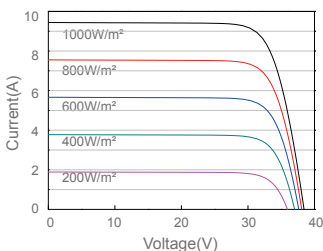

Power-Voltage Curve JAP60S09-280/SC

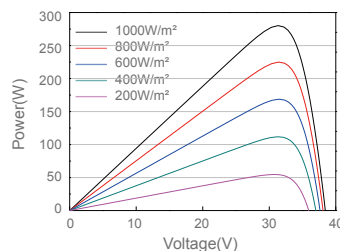

Current-Voltage Curve JAP60S09-280/SC

